

# LUNERA HID LED LAMP

## LED Replacement for High Intensity Discharge Lamps

[20,000lm / 15,000lm / 9,000lm / 4,500lm]  
Mogul Base - Vertical Mount - Ballast Driven



### Description

The Lunera HID LED lamp is a Ballast Driven (plug-and-play) LED replacement for Metal Halide (MH) and High Pressure Sodium (HPS) lamps with an E39 mogul base. This lamp replaces 400W~175W wattages of MH and HPS lamps in lighting applications such as High Bay, Low Bay, Parking Garages.

Lunera HID LED lamps feature a significantly lower energy consumption than conventional (High Intensity Discharge) HID lamps. These lamps deliver over 60% energy savings and have a rated life of 50,000 hours – 3 times longer than that of HID lamps.

Lunera's BallastLED technology makes these lamps truly plug-and-play by allowing them to operate directly off of existing magnetic HID ballasts.

The Lunera HID LED lamp is available in a range of color temperatures including 3500K, 4000K and 5000K. It delivers consistent light levels across its long life, which results in a high quality lighting experience for the building's occupants.

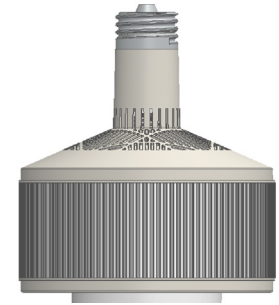

20,000lm  
15,000lm  
V

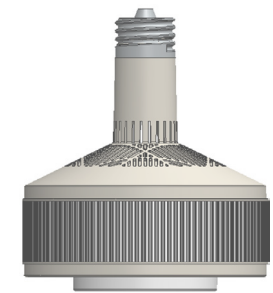

9,000lm  
4,500lm  
VS

### Features

- Replaces 400W ~ 175W High Intensity Discharge (MH and HPS) lamps
- Ballast-Driven plug-and-play installation; with existing magnetic HID ballast
- Works well in enclosed fixtures
- Up to 20,000, 15,000, 10,000 and 5,000 lumens fixture delivered light output
- Yields 60%-80% energy savings
- >80 CRI
- CCT 3500K, 4000K and 5000K
- Supports E39/EX39 Mogul base HID sockets
- Thermal IQ to support ambient temperatures up to 150°F



### Ordering Information

Example: SN-V-E39-B-20KLM-840-G3

Series	Version	Socket Type	Power Supply	Lamp Lumens	CCT	Generation
<b>SN:</b> Lunera HID LED	<b>V:</b> Vertical Base [20KLM and 15KLM]	<b>E39:</b> Fits in mogul-base (E39/EX39) HID socket	<b>B:</b> Plug-and-Play Magnetic HID Ballast	<b>20KLM:</b> 20,000lm <b>15KLM:</b> 15,000lm <b>9KLM:</b> 9,000lm <b>4.5KLM:</b> 4,500lm	<b>835:</b> 80CRI / 3500K <b>840:</b> 80CRI / 4000K <b>850:</b> 80CRI / 5000K	<b>G3:</b> 3rd Generation
<b>SNSA:</b> Lunera HID LED Sensor Lamp	<b>VS:</b> Vertical Short Base [9KLM and 4.5KLM]					

PROJECT	CONTACT	MODEL NO.
REFERENCE NO.	QUANTITY	DATE

For Technical Support:

[www.lunera.com](http://www.lunera.com)

T (650) 241-3874

1 of 5

<https://lunera.com/freshdesk.com/support/home>

## Performance Specifications - Vertical Mount Lamp - 20,000lm / 15,000lm

	20,000 lumens	15,000 lumens
<b>Illumination</b>		
Color Temperatures	3500K, 4000K, 5000K	3500K, 4000K, 5000K
Lumens	3500K: 20,800lm 4000K: 20,618lm 5000K: 21,920lm	3500K: 16,210lm 4000K: 15,764lm 5000K: 16,910lm
Color Consistency	Lunera TruColor proprietary process	Lunera TruColor proprietary process
Lumen Maintenance (L70)	50,000+ hours life	50,000+ hours life
<b>Electrical System</b>		
Input Voltage	Dependent of HID ballast CWA Ballast Input (480V ~ 120V) HX Ballast Input (277V ~ 120V)	Dependent of HID ballast CWA Ballast Input (480V ~ 120V) HX Ballast Input (277V ~ 120V)
Average Lamp Power	230W	164W
Lamp Wattage Replaced	400W/320W/310W/250W	400W/320W/310W/250W
<b>Physical</b>		
Dimensions (H x W)	9.88" x 6.31"	9.88" x 6.31"
Weight	2.75lb	2.75lb
Housing and Finish	Painted	Painted
Heat Sink Size	6"	6"
Configuration	Vertical Standard Base/Heatsink (V)	Vertical Standard Base/Heatsink (V)
Lens	Clear	Clear
<b>Environment</b>		
Ambient Temperature	-40°F to 150°F*	-40°F to 150°F*
Humidity Rating	Damp OK, no direct water spray	Damp OK, no direct water spray
Fixture Type	Open or enclosed	Open or enclosed
<b>Installation</b>		
Socket Type	Fits vertical mount mogul base (E39/EX39) HID socket	Fits vertical mount mogul base (E39/EX39) HID socket
<b>Certifications &amp; Qualifications</b>		
UL	Classified / Recognized US, CAN	Classified / Recognized US, CAN
RoHS Compliant	Contains no lead or mercury	Contains no lead or mercury
LM79, LM80, IES Files	Available	Available
DesignLights Consortium	DLC category not available	DLC category not available
<b>Warranty</b>		
Warranty	5 years	5 years

\*Thermal IQ is a proprietary Lunera technology which enables the Susan Lamp to operate reliably up to 150°F ambient by dimming itself at extreme temperatures based upon thermal characteristics of the fixture in which it has been installed.

\* Lamp dimming profiles subject to ballast type and environmental conditions. Contact Lunera for more detailed information.

## Performance Specifications - Vertical Mount Lamp - 9,000lm / 4,500lm

	9,000 lumens	4,500 lumens
<b>Illumination</b>		
Color Temperatures	3500K, 4000K, 5000K	3500K, 4000K, 5000K
Lumens	3500K: 8,817lm 4000K: 8,794lm 5000K: 9,170lm	3500K: 4,644lm 4000K: 4,800lm 5000K: 4,911lm
Color Consistency	Lunera TruColor proprietary process	Lunera TruColor proprietary process
Lumen Maintenance (L70)	50,000+ hours life	50,000+ hours life
<b>Electrical System</b>		
Input Voltage	Dependent of HID ballast CWA Ballast Input (480V ~ 120V) HX Ballast Input (277V ~ 120V)	Dependent of HID ballast CWA Ballast Input (480V ~ 120V) HX Ballast Input (277V ~ 120V)
Average Lamp Power	103W	58W
Lamp Wattage Replaced	250W/175W/150W/100W/70W	175W/150W/100W/70W
<b>Physical</b>		
Dimensions (H x W)	8.59" x 6.31"	8.59" x 6.31"
Weight	1.9lb	1.9lb
Housing and Finish	Painted	Painted
Heat Sink Size	6" Small	6" Small
Configuration	Vertical Short Base/Heatsink (VS)	Vertical Short Base/Heatsink (VS)
Lens	Frosted or Type V Option	Frosted or Type V Option
<b>Environment</b>		
Ambient Temperature	-40°F to 150°F*	-40°F to 150°F*
Humidity Rating	Damp OK, no direct water spray	Damp OK, no direct water spray
Fixture Type	Open or enclosed	Open or enclosed
<b>Installation</b>		
Socket Type	Fits vertical mount mogul base (E39/EX39) HID socket	Fits vertical mount mogul base (E39/EX39) HID socket
<b>Certifications &amp; Qualifications</b>		
UL	UL Classified & Recognized	UL Classified & Recognized
RoHS Compliant	Contains no lead or mercury	Contains no lead or mercury
LM79, LM80, IES Files	Available	Available
DesignLights Consortium	DLC category not available	DLC category not available
<b>Warranty</b>		
Warranty	5 years	5 years

\*Thermal IQ is a proprietary Lunera technology which enables the Susan Lamp to operate reliably up to 150°F ambient by dimming itself at extreme temperatures based upon thermal characteristics of the fixture in which it has been installed.

\*Lamp dimming profiles subject to ballast type and environmental condition. Contact Lunera for more detailed information.

## Photometry

Optical data is based on performance of bare lamps.

### Polar Candela Distribution [20,000lm / 15,000lm]

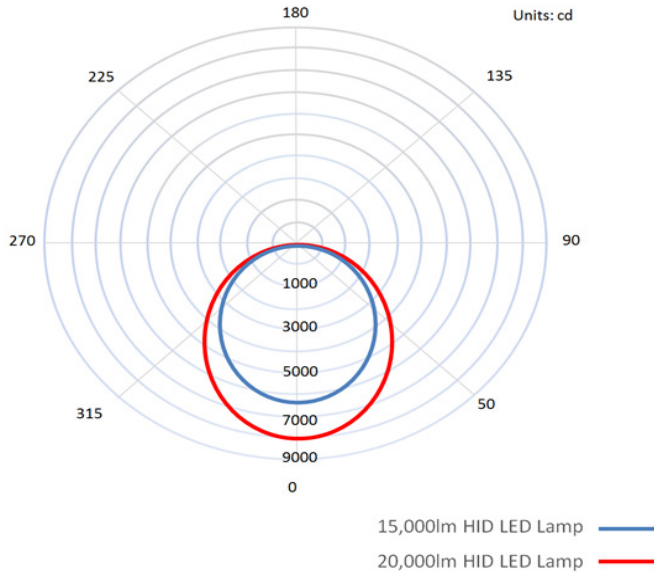



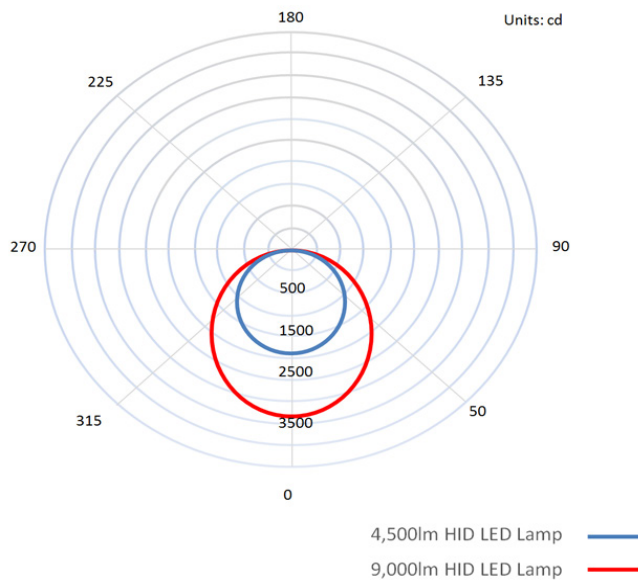

### Polar Candela Distribution [9,000lm / 4,500lm]

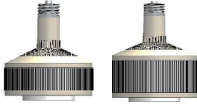

## Intended Applications

The Lunera HID LED lamp is designed to replace Metal Halide (MH) and High Pressure Sodium (HPS) lamps in the following compatible applications:

Wattage Compatibilities	Sockets	Power Source	Mount
<b>Lunera HID LED Mogul (E39) Base</b>  400W -70W MH or HPS	E39 / EX39 Mogul 	Magnetic HID Ballast 	Vertical Mount High Bay / Low Bay <b>Fixture Type</b>  High Bay Low Bay

## Application Notes

The Lunera HID LED lamp can be used in open and fully enclosed fixtures.

This device is NOT rated for use with dimmers.

Lunera HID LED Lamps supports operation with following ballasts:

Ballast Type	Ballast Input Voltage	Ballast Wattage
Constant Wattage Autotransformer (CWA)	480V ~ 120V	400W ~ 70W
High Reactance (HX)	277V ~ 120V	400W ~ 70W

Contact Lunera for luminaire level IES files with high bay and low bay DLC referenced fixtures.

Lunera HID LED lamp does NOT support operations with electronic HID ballasts.

This product is NOT intended for use with emergency lighting or for emergency lighting.

Warranty will be voided if the product is installed into/with the following:

- CWA or HX ballast with power rating above 400W
- HX ballast with input voltage above 277V
- Installed with dimmers
- Electronic HID ballast

## Caution

Turn power off when installing this lamp.

## Product Dimensions

Measurements are exact. Dimensions are shown in millimeters and inches. Please contact your Lunera representative for other product dimensions.

### Vertical E39 Lamp Standard Body/Heatsink 20,000lm / 15,000lm

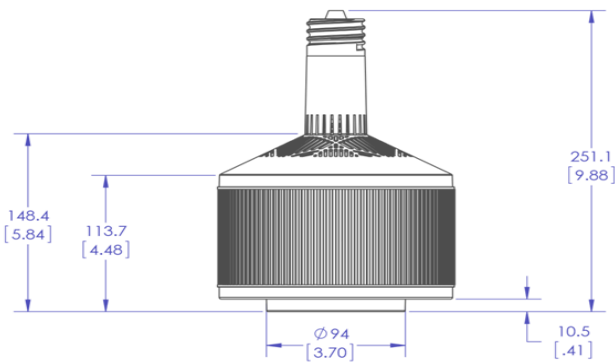
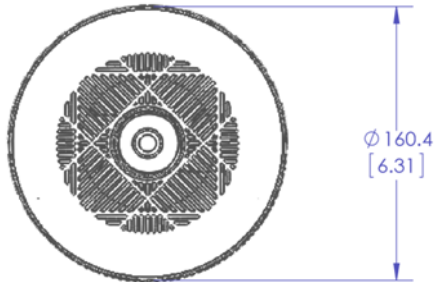

### Sample Part Numbers:

SN-V-E39-B-20KLM-8XX-G3  
SN-V-E39-B-15KLM-8XX-G3

'XX' : may be 35 (3500K), 40 (4000K), or 50 (5000K)

## CAUTION

Turn off power when installing the lamp.

For FAQ and Technical Support, please visit:  
<https://lunera.freshdesk.com/support/home>

### Vertical E39 Lamp Short Body/Heatsink 9,000lm / 4,500lm

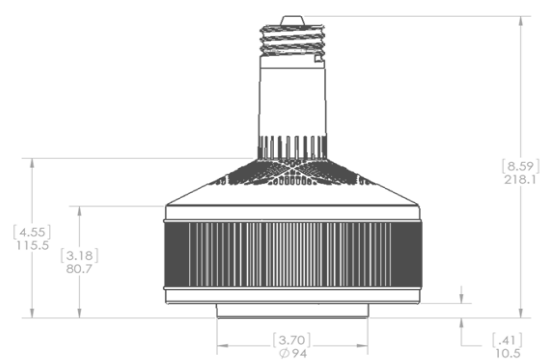
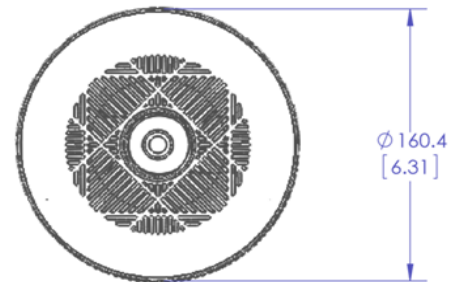

### Sample Part Numbers:

SN-VS-E39-B-9KLM-8XX-G3  
SN-VS-E39-B-4.5KLM-8XX-G3

'XX' : may be 35 (3500K), 40 (4000K), or 50 (5000K)